

Automat dozujący AUTODOS 2000 , 4000

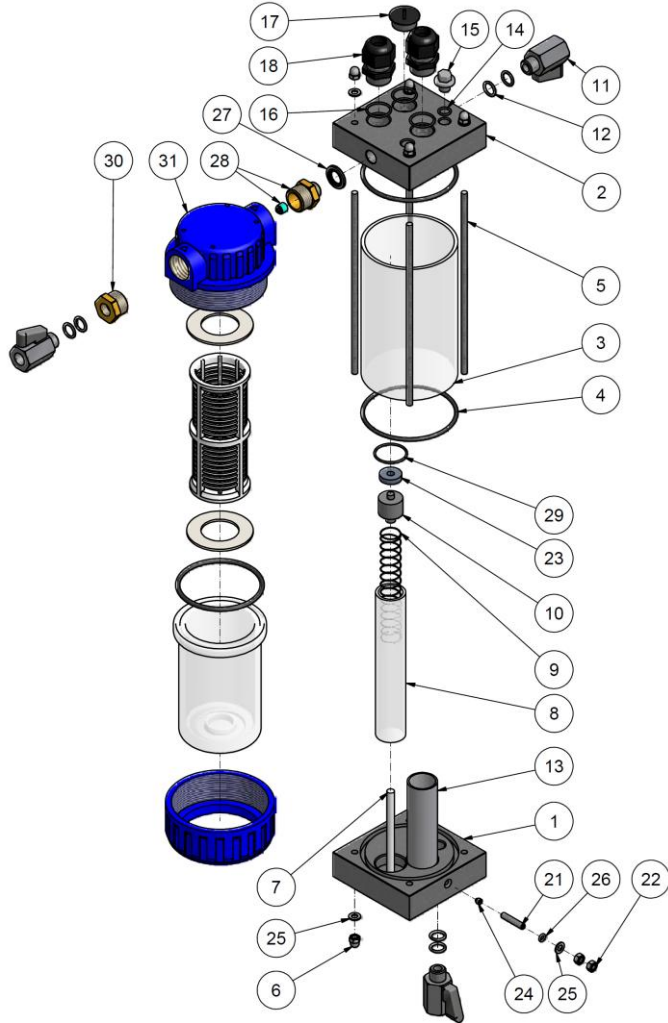

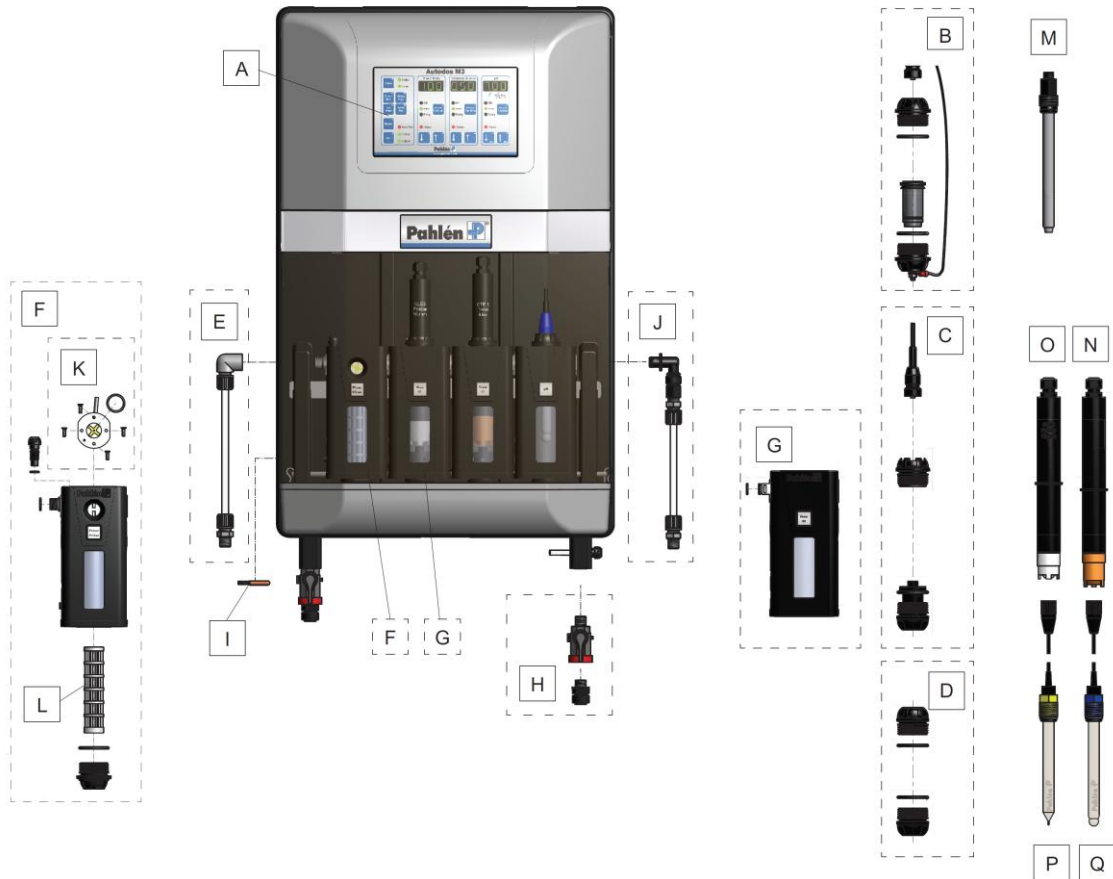



















Automat dozujący AUTODOS M1 , M2 ,M3



Ceny części na zapytanie

Automat dozujący EURODOS



Nazwa	Zdjęcie towaru	Nr art.	Cena netto w EUR / szt
komora pomiarowa bez złączek		e8401111	330,00
Elektroda pH bez kabla		e2211503	114,40
Elektroda Redox bez kabla		e2311503	119,24
Kabel elektrody		e8311014	33,00
pierścień 10mm		e9090220	2,75
zaworek wtrysku		e3121002	8,25
pierścień 6mm		e9090210	2,75
wąż dozujący śr.6 mm , 1mb		e8701001	1,60
wąż wody pomiarowej śr.10mm ,1mb		e8701000	1,60
kółko pompy dozującej FX		e800965	13,50
węzyk pompy FX 2l/h		e800960	10,65
nypel dozujący gwint 3/8 cala		416634	7,22
nypel dozujący de luxe do komory Eurodos gwint 3/8 cala		3121010	59,74
nypel dozujący gwint 1/4 - 1/2" cala		416630	29,87
redukcja GZ 3/8" i 1/2";GW 1/4"		e8601002	17,38
zawór wody pomiarowej		e8501036	9,99
nypel węża 10 mm , GZ 1/4"		e8601006	18,37
roztwór buforowy pH 7		e8001016	9,90
roztwór buforowy pH 9		e8001017	9,90
roztwór Redox 465mV		e8001020	16,06
zaśleпка wejścia elektrody		e8602020	2,4



Lampa UV



Model UV-C Tech

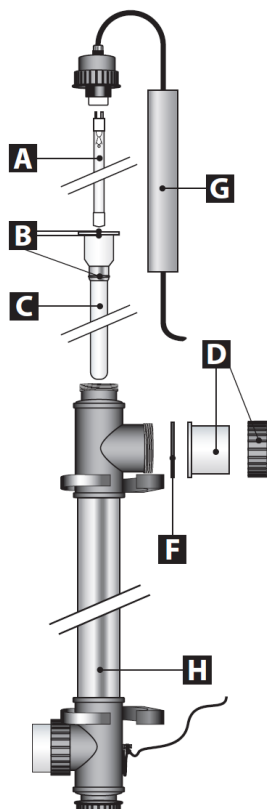

Nr art.	Nazwa artykułu	Numer części	Cena netto w EUR /szt
e910002	obudowa lampy	H	174,42
e980917	osłona	C	65,43
e800912	uszczelki osłony (3 sztuki)	B	5,70
e980002	wkład lampy UV 40 Watt	A	54,93
e914001	elem.elektryczny 40 W	G	100,95
e915000	śrubunek	D	13,65
e800941	uszczelka śrubunka (2 sztuki)	F	3,15
e980004	wkład lampy UV 75 Watt	A	79,77
e914002	elem.elektryczny 75 W	G	112,14
e914003	nakrętka zaślepiająca		13,50

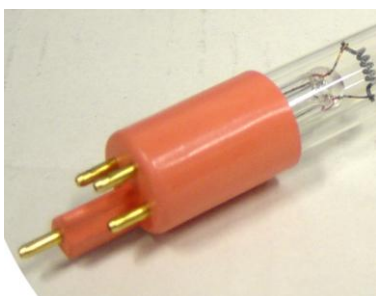

Model Budget

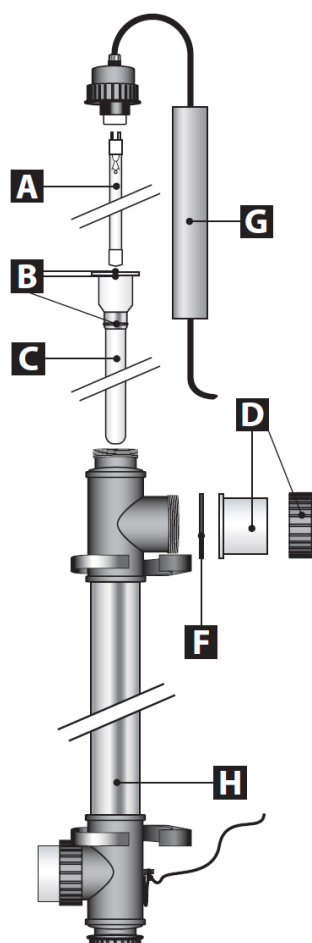

Nr art.	Nazwa artykułu	Numer części	Cena netto w EUR /szt
e910002	obudowa lampy	H	174,42
e800956	osłona	C	29,25
e800912	uszczelki osłony (3 sztuki)	B	7,74
e915000	śrubunek	D	13,65
e800941	uszczelka śrubunka (2 sztuki)	F	3,15
e980006	wkład lampy UV 75 Watt Budget	A	50,13
e914002	elem.elektryczny 75 W	G	112,14
e914004	nakrętka zaślepiająca		13,50

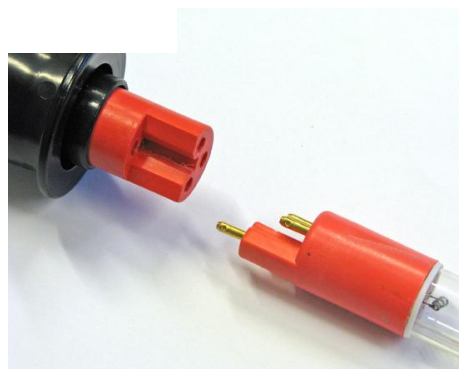

Elektryczny podgrzewacz wody – obudowa z tworzywa

Ceny części na zapytanie

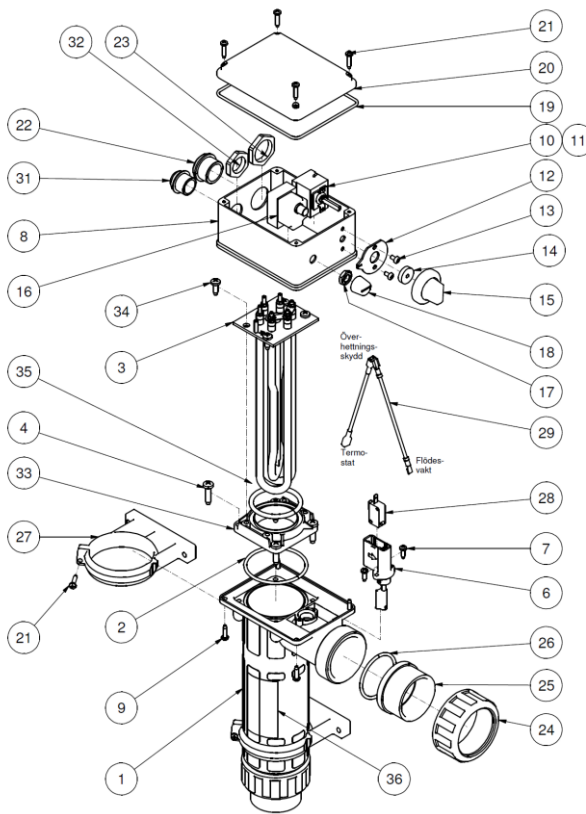

Elektryczny podgrzewacz wody – obudowa ze stali

Nr art.	Nazwa towaru	Cena netto w EUR /szt
e41800	grzałka zapasowa 6 kW	165,90
e41802	grzałka zapasowa 9 kW	170,93
e41804	grzałka zapasowa 12 kW	183,21
e41806	grzałka zapasowa 15 kW	188,21
e41808	grzałka zapasowa 18 kW	193,35
e41812	Termostat 0 - 40 stopni	127,68
e41814	termostat bezpieczeństwa 60 stopni	127,68
e41816	czujnik ciśnieniowy grzałki	79,66
e41790	grzałka 6 kW dla wer.tytanowej	295,60
e41792	grzałka 9 kW dla wer.tytanowej	299,88
e41794	grzałka 12 kW dla wer.tytanowej	312,87
e41796	grzałka 15 kW dla wer.tytanowej	317,44
e41798	grzałka 18 kW dla wer.tytanowej	323,30

